

Save these instructions  
for future use!

**1F85RF-275 Thermostat and  
Wireless Remote Sensor Kit**

Automatic Heat/Cool Changeover Thermostat for Single Stage/  
Multi-Stage/Heat Pump Systems with Wireless Remote Sensor

**FAILURE TO READ AND FOLLOW ALL INSTRUCTIONS  
CAREFULLY BEFORE INSTALLING OR OPERATING THIS  
CONTROL COULD CAUSE PERSONAL INJURY AND/OR  
PROPERTY DAMAGE.**

**Installation and Operating Instructions for Model:**

Model	Programming Choices	
1F85RF-270	Non-Programmable	5/1/1 Day
F145RF-1328	Wireless Remote Sensor	

**APPLICATIONS**

**THERMOSTAT APPLICATION GUIDE**

Description	
Heat Pump (No Auxiliary or Emergency Heat)	Yes
Heat Pump (with Auxiliary or Emergency Heat)	Yes
Standard Heat & Cooling Systems	Yes
Multi-Stage Systems requiring more than One Call for Heat or Cool	Yes
Standard Heat Only Systems	Yes
Millivolt Heat Only Systems – Floor or Wall Furnaces	No
Standard Central Air Conditioning	Yes
Gas or Oil Heat	Yes
Electric Furnace	Yes
Hydronic (Hot Water) Zone Heat – 2 Wires	* Yes
Hydronic (Hot Water) Zone Heat – 3 Wires	No

\* Common Connection Required



1F85RF-270

Wireless Remote Sensor

**SPECIFICATIONS**

**Thermostat:**

Electrical Ratings ..... 20 to 30 VAC 50/60 Hz  
0.2 to 0.6 Amps per Load  
(Y1, E/W1, G)  
1.5 Amps (Y2, W2, O, B  
Load per terminal)  
1.5 Amps Max  
(All terminals combined)  
Setpoint Range ..... 45 to 90°F (7 to 32°C)  
Rated Differential (Single Stage) ... Heat 0.6° or 1.5°F, Cool 1.2°F  
Rated Differential (Multi-Stage) ..... Heat 0.6° or 1.5°F, Cool 1.2°F  
Rated Differential (Heat Pump) ..... Heat & Cool 0.75° or 1.2°F  
Operating Ambient ..... 32 to +105°F (0 to +41°C)  
Operating Humidity ..... 90% non-condensing max.  
Shipping Temp. Range ..... -4 to +150°F (-20 to +65°C)  
Thermostat Dimensions ..... 3-3/4"H x 6"W x 1-1/4"D

**Remote Sensor:**

**This device complies with Part 15 of the FCC Rules, Operation is subject to the following two conditions: (1) this device may not cause harmful interference, and (2) this device must accept any interference received, including interference that may cause undesired operation.**  
Maximum Wireless Remote Sensors ..... 1 indoor, 1 outdoor  
Operating Range ..... 45 to 90°F (7 to 32°C)  
Operating Humidity Range ..... 0 to 90% RH  
(non-condensing)  
Dimensions ..... 2-5/8"H x 4-1/4"W x 7/8"D  
\* Max. Distance from Thermostat ..... 200 feet

\* Distance shown is for a typical application. Distances may vary in some applications because obstacles that block the signal path may affect the strength of the signal.

**CAUTION**

**To prevent electrical shock and/or equipment damage, disconnect electric power to system at main fuse or circuit breaker box until installation is complete.**

**ATTENTION: MERCURY NOTICE**

This product does not contain mercury. However, this product may replace a product which contains mercury.

Mercury and products containing mercury must not be discarded in household trash. Do not touch any spilled mercury. Wearing non-absorbent gloves, clean up any spilled mercury and place in a sealed container. For proper disposal of a product containing mercury or a sealed container of spilled mercury, place it in a suitable shipping container and send it to:

**White-Rodgers  
2895 Harrison Street  
Batesville, AR 72501**

Index	Page
Installation	2
Wiring Connections	3
Thermostat/Sensor Quick Reference	4
Installer Configuration Menus	6
Operating Your Thermostat and Sensor	9
Programming	13
Troubleshooting	14

# INSTALLATION

## ⚠ WARNING

Thermostat installation and all components of the control system shall conform to Class II circuits per the NEC code.

### Remove Old Thermostat

A standard heat/cool thermostat consists of three basic parts:

1. The cover, which may be either a snap-on or hinge type.
2. The base, which is removed by loosening all captive screws.
3. The switching subbase, which is removed by unscrewing the mounting screws that hold it on the wall or adapter plate. **Before removing wires from old thermostat, label each wire with the terminal designation from which it was attached.** Disconnect the wires from the old thermostat one at a time. **Do not let wires fall back into the wall.**

### Guidelines for Thermostat/Sensor Locations

Locate the thermostat/sensor about 5 ft. above floor level on an interior wall in an area that represents the average room temperature.

Do not mount directly on or near HVAC equipment or other sources of electrical noise.

Avoid locations close to windows or near adjoining outside walls, doors leading outside, areas close to air registers or their direct air flow or areas with poor circulation like alcoves. Avoid locating the sensor on a concrete wall, junction box or metal plate. Make sure there are no electrical wires, metal, pipes or duct work in the part of the wall chosen for the sensor location.

**Thermostat and indoor sensor are not approved for installation in unconditioned space.**

### Mounting Thermostat and Sensor

1. Remove the packing material from the thermostat and sensor.
2. Pull the front covers of the thermostat and sensor straight off the bases. Forcing or prying will cause damage to the controls.
3. Using the thermostat and sensor bases as templates, place them on the selected wall locations and mark the location of all mounting holes (Figure 1 and 3), and the hole for the thermostat antenna wire illustrated in Figure 2.
4. Move bases out of the way and drill the holes. If mounting holes drilled are too large and do not allow you to tighten base snugly, use the plastic screw anchors (provided) for secure mounting.
5. Make sure the remote communication receiver is plugged in properly to the thermostat and that the antenna wire is routed through the thermostat subbase as shown in Figure 2.
6. Fasten bases loosely to wall, using two mounting screws for each. Place a level against bottom of base (leveling is for appearance only and will not affect sensor operation) and then tighten screws.
7. In the thermostat location, push excess wire into wall and plug hole with a fire resistant material (such as fiberglass insulation) to prevent drafts from affecting the thermostat operation.

8. Remove the battery tags in both the thermostat and sensor and replace the covers by lining them up with the base and pressing until they snap into place.

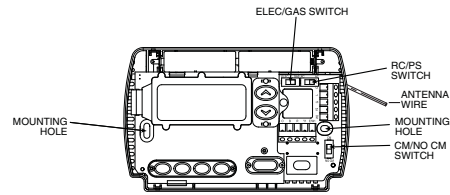

Figure 1 – Thermostat base

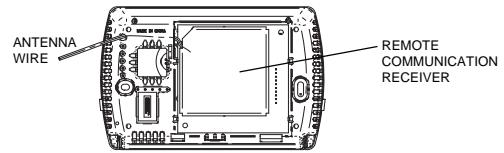

Figure 2 – Back of thermostat base

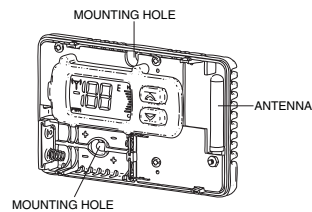

Figure 3 – Remote sensor base

### Battery Location

The thermostat requires 2 "AA" alkaline batteries and the sensor requires 2 "AAA" alkaline batteries. Batteries are included at the factory with a battery tag to prevent power drainage. The battery tag must be removed to engage the batteries. For best results, replace batteries once a year with new premium brand alkaline batteries such as Duracell® or Energizer®.

### Electric/Gas Switch (Fan Option)

The ELEC/GAS switch is factory set to the ELEC position. In this position, the thermostat will power the circulator fan on a call for heat. Electric heat systems may require the switch to be in the ELEC position.

If your system does not require that the thermostat power the circulator fan, this switch should be set to the GAS position. Typically, gas and oil heating systems do not require the thermostat to power the circulator fan during a call for heat. If your heat is gas or oil, the switch should be set to the GAS position.

When the thermostat is configured for Heat Pump, the thermostat will always power the circulator fan on a call for heat in the HEAT mode. The ELEC/GAS switch must be set to match the type of Auxiliary heat your system uses for proper operation in the EMERGENCY mode.

### RC/PS Switch (Thermostat Power Option)

RC/PS Switch Position	Description
RC	For Hardwire Applications. Requires Common Wire from System Transformer to "C" Terminal on Thermostat
PS	For Power Stealing Applications. Use When Common from the System Transformer is not Available for Connection to the "C" Terminal on the Thermostat

NOTE: If set to PS (Power Stealing), the thermostat "C" terminal **must not** have a wire connected.

# WIRING CONNECTIONS

Typical wiring diagrams are provided below for the following systems:

- Single Stage Heat/Cool systems
- Multi-Stage Heat/Cool systems (No Heat Pump)
- Heat Pump system, one compressor or one speed compressor with Aux. Heat
- Heat Pump systems, two compressors or two speed compressor with Aux. Heat

Refer to the equipment manufacturers instructions for specific wiring information. After completing the connections configure the thermostat in the Installer Configuration Menu to match your system type.

**Figure 4 – Single Stage (No Heat Pump) Terminal Outputs**

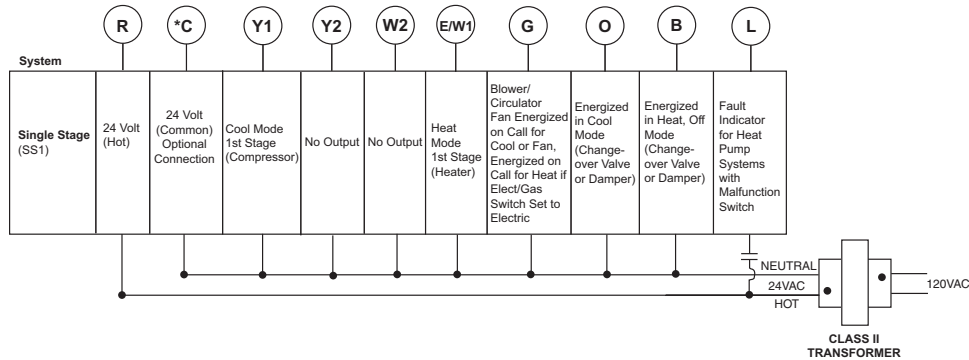

\* The RC/PS switch shown in Figure 1 configures the thermostat for Hardwire or Power Stealing.

The factory setting is RC (Hardwire) and requires a Common connection from the system transformer to the "C" terminal on the thermostat. If no common wire is available for the thermostat "C" terminal, move the RC/PS switch to PS (Power Stealing). **NOTE:** If set to PS (Power Stealing), the thermostat "C" terminal **must not** have a wire connected.

**Figure 5 – Multi-Stage (No Heat Pump) Terminal Outputs**

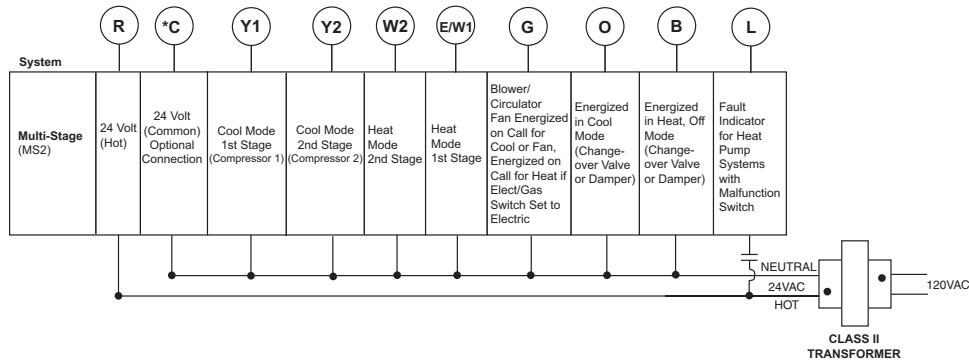

\* The RC/PS switch shown in Figure 1 configures the thermostat for Hardwire or Power Stealing.

The factory setting is RC (Hardwire) and requires a Common connection from the system transformer to the "C" terminal on the thermostat. If no common wire is available for the thermostat "C" terminal, move the RC/PS switch to PS (Power Stealing). **NOTE:** If set to PS (Power Stealing), the thermostat "C" terminal **must not** have a wire connected.

**Figure 6 – Heat Pump Terminal Outputs**

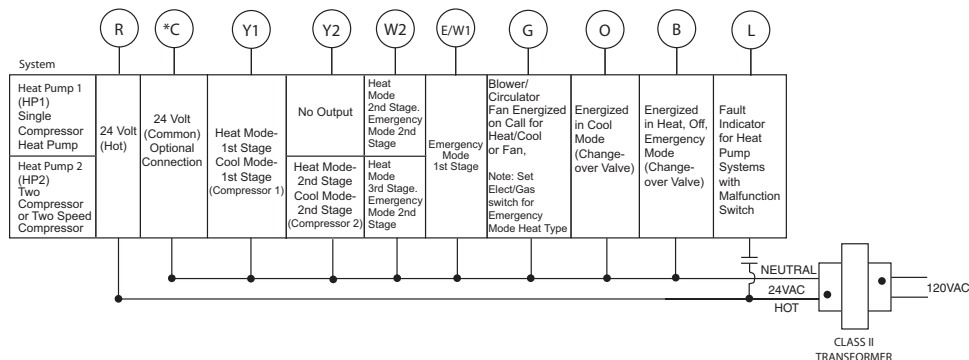

\* The RC/PS switch shown in Figure 1 configures the thermostat for Hardwire or Power Stealing.

The factory setting is RC (Hardwire) and requires a Common connection from the system transformer to the "C" terminal on the thermostat. If no common wire is available for the thermostat "C" terminal, move the RC/PS switch to PS (Power Stealing). **NOTE:** If set to PS (Power Stealing), the thermostat "C" terminal **must not** have a wire connected.

# THERMOSTAT/REMOTE SENSOR QUICK REFERENCE

Before operating the thermostat, familiarize yourself with the display and button functions. Both thermostat and remote sensor consist of two parts: the cover and the base. To remove a cover, pull it straight out from the base. To replace a cover, line it up with the base and press until the cover snaps into place on the base.

## The Thermostat Buttons and Switches and Display

- ① Raises and lowers the temperature setting.
- ② Light flashes every 20 seconds indicating acceptable signal reception from indoor or outdoor remote sensor.
- ③ Buttons for setting time (Time), programming (Prgm), running program (Run) and bypassing program to hold a constant temperature (Hold).
- ④ SYSTEM button (COOL, AUTO, HEAT, OFF, EMER heat pump systems only).
- ⑤ FAN switch (ON, AUTO).
- ⑥ Displays the active temperature sensor (outside, remote, local) and its sensed temperature.
- ⑦ Displays  when in keypad lockout mode.
- ⑧ Indicates day of the week.
- ⑨ Indicates the thermostat mode information: "HOLD" alternates with the system mode (see item 12) if the HOLD button is pressed to bypass the program and maintain a constant temperature.
- ⑩ Displays currently programmed set temperature (blank when SYSTEM is OFF).
- ⑪ Alternately displays the current time and the temperature average of sensors (thermostat [local] and/or indoor remote) turned on.
- ⑫ "HEAT" is displayed when set to heating, "COOL" is displayed when set to cooling, "AUTO" is displayed when set for automatic change-over between heating and cooling. When "AUTO" is displayed, the currently active mode (Heat or Cool) will also display. "EMER" is displayed flashing (heat pump systems only) when the thermostat is set to the Emergency Mode. Emergency is used to bypass the heat pump and use only the back-up heating system. "FLTR" is displayed as a reminder to change or clean the air filter after system has run for the programmed filter time period.
- ⑬ Stage 1 & 2 indicator. "STG 1" indicates when the first stage heat or cool is energized. "STG + 2" indicates when the second stage heat or cool is energized. "+2" blinking indicates Auxiliary Heat stages are energized on Heat Pump Systems.

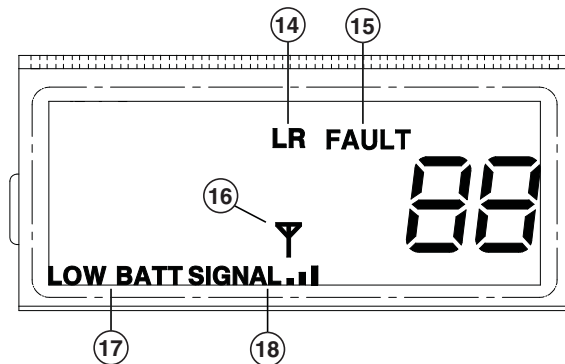
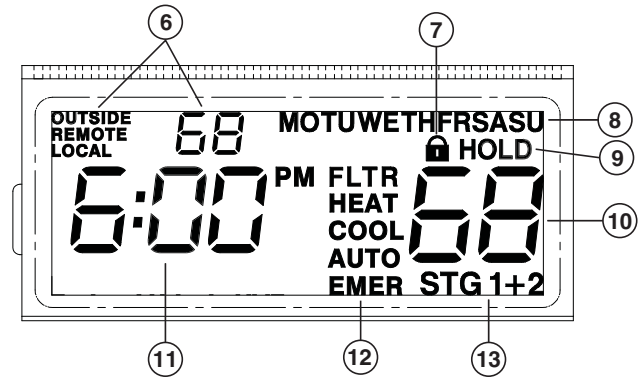
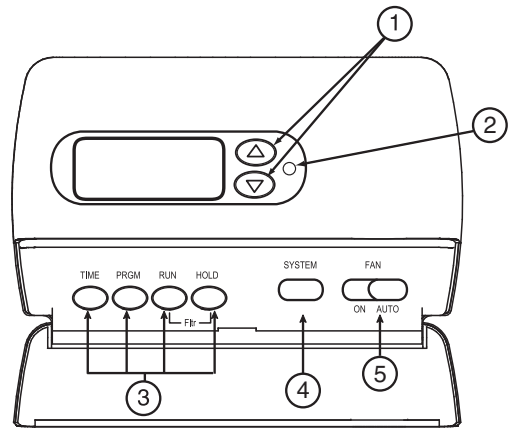

Figure 7 – Thermostat display, buttons and switches

- ⑭ Displays "LR" when the limited range feature is activated. Limited range limits the temperature the thermostat can be set to.
- ⑮ Indicates the system is sending a fault signal to the thermostat "L" terminal. This does not indicate a fault in the thermostat.
- ⑯ Antenna will display for a few seconds when the remote or outdoor transmitted signal is received.
- ⑰ Displays "LOW BATT" when the 2 "AA" batteries are low and should be replaced.
- ⑱ Indicates the current signal strength level of the remote temperature system. Signal strength level is low (one bar on), medium (two bars on) or high (three bars on). The remote will operate with 1 bar showing.

# THERMOSTAT/SENSOR QUICK REFERENCE

## The Sensor Buttons and Display

- ① Raises the setting.
- ② Lowers the setting.
- ③ Sensed temperature from **-40 to 140°F** with °F and °C indicator
- ④ Channel identification **A B C O** indicator
- ⑤ 9 bar comfort adjust graph with H (hotter) and C (cooler)
- ⑥ Transmission occurrence indicator
- ⑦ Keypad lockout indicator
- ⑧ Calibrate temperature offset indicator
- ⑨ Learn mode activated indicator
- ⑩ Low battery indicator
- ⑪ Temperature offset used when hold time is active
- ⑫ Alternates **PWR** and **on** to indicate normal operation with display turned OFF

Figure 8 – Remote Sensor display and buttons

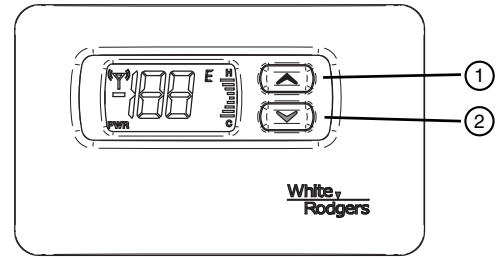

### Normal Operation

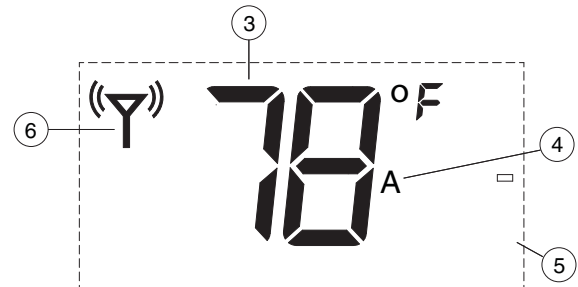

### Configuration Items

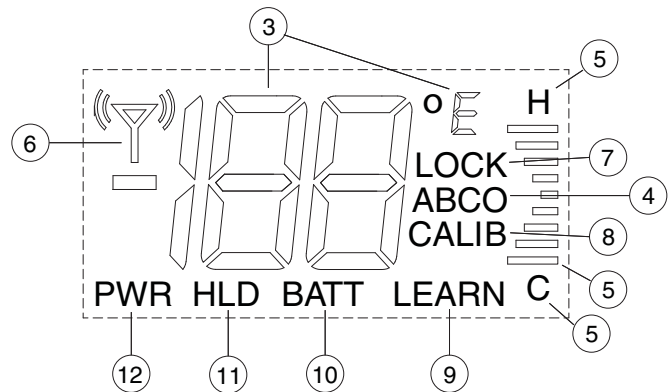





# THERMOSTAT CONFIGURATION MENU

INSTALLER/CONFIGURATION MENU				
Press the System button until OFF is displayed, then press the  and  simultaneously				
Step	Press Button(s)	Displayed (Factory Default)	Press  or  to select	Comments
1	System	MS2	SS1, HP2, HP1	Selects Single stage, Multi-stage, or Heat Pump (Single stage or 2-stage) system configuration
2	System	LER (OFF)	LER (ON)	Selects learn mode OFF or ON
3	System	OUTSIDE (OFF)	OUTSIDE (ON)	Selects OUTSIDE sensor OFF or ON
4	System	REMOTE (OFF)	REMOTE (ON)	Selects REMOTE (indoor) sensor OFF or ON
5	System	LOCAL (ON)	LOCAL (OFF)	Selects LOCAL sensor ON or OFF
6	System	CH (0)	1 to 9	Select Receiver frequency offset
7	System	PRG 4	PRG 0, PRG 2	Selects Programmable Periods
8	System	EMR (ON)	EMR (OFF)	Selects Energy Management Recovery OFF or ON
9	System	CR HEAT COOL (FA)	SL	Selects Fast or Slow cycle selection
10	System	CL (OFF)	CL (ON)	Selects Compressor Lockout CL OFF or ON
11	System	CdL (ON)	CdL (OFF)	Selects Backlight Display ON or OFF
12	System	FA HEAT COOL (ON)	FA HEAT COOL (OFF)	Selects Fast Second Stage ON or OFF
13	System	0 FLTR	0–1950 (increments of 50)	Selects filter replacement run time. 0 =Disabled
14	System	0 F (Room Temperature)	4 LO to 4 HI	Selects Temperature Display Adjustment 4 LO 4 HI
15	System	4:00 HOLD	0:00 to 8:00 (Increments of 15 minutes)	Selects Temporary Program Override Time 0:00 =Disabled
16	System	F	C	For C selection Selects temperature display as F° or C°
17	System	LR HEAT (90)	LR 62 to LR 89	Selects Limited HEAT range
18	System	LR COOL (45)	LR 46 to LR 82	Selects Limited COOL range
19	System	CA (OFF)	CA (ON)	Selects Comfort Alert Lock
20	System	OFF LOCK	ON LOCK	Selects Buttonpad Lockout
21		0 00 LOCK	001 to 999	Selects Buttonpad lockout combination number Press System to set code
	Run			Returns to the OFF mode

The configuration menu allows you to set certain thermostat operating characteristics to your system or personal requirements.

Set SYSTEM button to OFF, then simultaneously press  and  to enter configuration menu. The display will show the first item in the configuration menu.



The configuration menu table summarizes the configuration options. An explanation of each option follows.



Press SYSTEM to change to the next menu item. To exit the menu and return to the program operation, press RUN. If no keys are pressed within fifteen minutes, the thermostat will revert to normal operation.

## 1) Single Stage, Multi-stage or Heat Pump Configuration

This menu item requires you configure the thermostat to match your system. Choose your system option from the table below:



















System Type	Select Option
Single Stage Heat/Cool systems	SS1
Multi-Stage Heat/Cool systems (No Heat Pump)	MS2
Heat Pump system, 1 compressor or 1 speed compressor	HP1
Heat Pump systems, 2 compressors or 2 speed compressor	HP2

The thermostat is factory defaulted to MS2. To select a different option, press the  or  key to scroll through the choices.

- 2) **Select Learn Mode On or Off** – Selecting **LER On** enables the learn mode of the thermostat receiver. Your thermostat is configured at the factory to recognize the remote sensor shipped with it. The Learn Mode Option is used only when required as described in **Learn Mode Option**.
- 3) **Selects OUTSIDE sensor OFF or ON** – Selecting OUTSIDE ON enables the thermostat to read a wireless outdoor temperature sensor that has been configured for Sensor O in the Learn Mode. This allows the thermostat to display the outdoor temperature reading.
- 4) **Selects REMOTE sensor OFF or ON** – Selecting REMOTE ON allows the thermostat to sense an indoor remote sensor that has been set-up the Learn mode. The maximum number of Indoor Remote Sensors is 1 configured to sensor A, B or C.
- 5) **Selects LOCAL sensor ON or OFF** – Selecting LOCAL ON allows the thermostat to use the onboard temperature sensor exclusively or for averaging with the remote sensor readings. To control temperature using only the indoor remote sensor temperature(s), use the  or  buttons to select **LOCAL OFF**.
- 6) **Select Receiver frequency offset** – This option allows you to select a different channel than the factory default for communication between the thermostat and remote sensor. Note: If a different channel is selected on the thermostat it must also be changed to the same

# THERMOSTAT CONFIGURATION MENU







setting on the remote. This is only used in areas where there are other wireless devices or electronic equipment that interfere with the default frequency of the thermostat/remote sensor communication.

- 7) **Programmable Periods** – This control can be configured for 4, 2 or 0 programmable periods. The display indicates "PRG 4" in the display as default. The programmable periods can be changed to 2 or 0 by pressing the  or  keys. With "PRG 0" selected for non-programmable, SYSTEM key selection will skip EMR (item 8) and temporary program override (item 15).
- 8) **Select Energy Management Recovery OFF or ON** – Energy Management Recovery (EMR) causes the thermostat to start heating or cooling early to make the building temperature reach the program setpoint at the time you specify. Heating will start 5 minutes early for every 1° of temperature required to reach setpoint.  
**Example:** You select EMR and have your heating programmed to 65° at night and 70° at 7 AM. If the building temperature is 65° the difference between 65° and 70° is 5°. Allowing 5 minutes per degree the thermostat setpoint will change to 70° at 6:35 AM. Cooling allows more time per degree because it takes longer to reach temperature.
- 9) **Fast or Slow Cycle Selection** – The factory default setting is fast cycle, which cycles 1st stage at approximately 1.2°F and 2nd stage 0.75°F. If you prefer slow cycle, press the temperature key to change to SL. The 1st stage and 2nd stage would be 1.5°F and 1.2°F respectively.
- 10) **Select Compressor Lockout CL OFF or ON** – Selecting CL ON will cause the thermostat to wait 5 minutes before turning on the compressor if the heating and cooling system loses power. It will also wait 5 minutes minimum between cooling and heating cycles. This is intended to help protect the compressor from short cycling. Some newer compressors already have a time delay built in and do not require this feature. Your compressor manufacturer can tell you if the lockout feature is already present in their system. When the thermostat compressor time delay occurs it will flash the setpoint for about five minutes.
- 11) **Select Backlight Display** – The display backlight improves display contrast in low lighting conditions. When the "C" terminal is powered, selecting backlight CdL ON will keep the light on continuously. Select backlight OFF will keep the light on momentarily after any key is pressed. When the "C" terminal is not powered, the light will be on momentarily after any key is pressed no matter the backlight is selected ON or OFF.
- 12) **Select Fast Second Stage On or OFF – For Heat:**  
During normal operation if the setpoint temperature is manually raised by 3°F or more above the actual temperature with the  button, and the fast second stage feature is enabled, FA ON, the second stage will energize immediately.  
For Cool: During normal operation if the setpoint temperature is manually lowered by 3°F or more below the actual temperature with the  button, and the fast second stage feature is enabled, FA ON, the second stage will energize immediately.
- 13) **Select filter replacement run time** – The thermostat will display "FLTR" after a set time of operation. This is a reminder to change or clean your air filter. This time can be set from 0 to 1950 hours in 50 hour increments. **A selection of 0 will cancel this feature.** When "FLTR" is displayed, you can clear it by pressing HOLD and RUN at the same time. This resets the timer and starts counting the hours until the next filter change. Contact your system manufacturer for a specific replacement/maintenance interval.
- 14) **Select Temperature Display Adjustment 4 LO to 4 HI** – Allows you to adjust the room temperature display up to 4° higher or lower. Your thermostat was accurately calibrated at the factory but you have the option to change the display temperature to match your previous thermostat. The current or adjusted room temperature will be displayed on the left side of the display.
- 15) **Select Temporary Program Override Time** – The thermostat can hold any temperature you set it to for the amount of time you select on this option. Your choices are 0:00 to 8:00 hours in 15 minute increments. 0:00 means disable. Example:
  1. You have selected 3:00 hours for the Temporary Program Override time period.
  2. With the thermostat set to Heat or Cool, press HOLD for approximately 5 seconds until "HOLD time 3:00" (indicating 3 hours) appears as a setting reminder.
  3. After releasing the button, "HOLD" on the display will blink.
  4. Use  or  to set the temperature to your preference. The thermostat will maintain this temperature setting for 3 hours with "HOLD" blinking to remind you it is in Temporary Hold. After 3 hours, the thermostat will go back to the program temperature and "HOLD" will no longer blink or display.
- 16) **Select F° or C° Readout** – Changes the display readout to Celsius or Fahrenheit as required.
- 17) **Limited Heat Range** – This feature provides a maximum setpoint temperature for heat. The default setting is 90°F. It can be changed between 62°F and 89°F by pressing the  or  key.
- 18) **Limited Cool Range** – This feature provides a minimum setpoint temperature for cool. The default setting is 45°F. It can be changed between 46°F and 82°F by pressing the  or  key.
- 19) **Comfort Alert** – This feature is available in Passive mode on this thermostat. If a Comfort Alert module is connected, the thermostat will receive and flash the fault codes from the Comfort Alert module.
- 20 & 21) **Keypad Lockout** – This menu selection will display lock  icon. The  and  are used to toggle the function and display the lock icon and OFF (keypad not locked out, default) indicating in the time digits to the lock icon and ON (keypad locked out). When the keypad lockout function is enabled (ON), and the SYSTEM button is pressed again, the display will indicate the number 000 (default, still disabled) in the time digits. The  and  are used to set the combination number from 0 to 999. If a combination of 000 is selected and the SYSTEM button is pressed, the menu will be exited and keypad will not be locked. If 1 to 999 is selected and the SYSTEM button is pressed again, the combination is locked into non-volatile memory and the menu is exited. The lock icon (to designate keypad locked with a valid combination) will display when the menu is exited. The SYSTEM button will operate for 10 seconds after the menu mode is exited to allow the user to change the mode from OFF to the desired system mode.  
  
While the keypad is locked out, a simultaneous press of  and  will enter the menu item from any mode instead of only OFF mode. When the menu is entered with the keypad lockout feature enabled, the first menu item displayed is the combination code 0. The  or  keys are used to set the combination unlock number from 0 to 999. If the unlock number matches exactly with the combination lock number stored in memory when the SYSTEM button is pressed, the keypad is unlocked and the lock icon is removed. If the unlock number does not match when the SYSTEM button is pressed, menu is exited and the keypad remains disabled.  
  
To reset the combination code and unlock the keypad if the code is forgotten, see troubleshooting section, page 16.

















# REMOTE SENSOR CONFIGURATION MENU







The configuration menus allow you to set certain remote sensor operating characteristics to your system or personal requirements. Two configuration menus are available, User Configuration and Installer Configuration.

## User Configuration Menu

Momentarily press  and  keys at the same time and release to enter the User menu. To scroll through the menu items press the  and  keys at the same time. To change the item option press  or . To exit the menu scroll through all menu items. If no buttons are pushed for 3 minutes, the control will also return to normal operation. The User Configuration Menu table summarizes the configuration options. An explanation of each option follows.

User configuration menu

Step	Press button(s) to scroll menu	Displayed (factory default)	Press  or  to change option	Comments
1	 and 	<b>LOCK</b> (OF)	on	Select keypad lockout OFF or ON
2	 and 	<b>HLD</b> (4h)	1 to 8 hrs in 1 hour increments	Select temporary adjust temperature hold time
3	 and 	<b>CALIB</b> (Sensed Temperature)	1-4 bars (1°-4°) C to 1-4 bars (1°-4°) H	Select temperature display adjustment higher or lower
4	 and 	d <sup>F</sup> (on)	OF	Select display temperature OFF or ON
5	 and 	d <sup>L</sup> (on)	OF	Select display backlight OFF or ON
6	 and 	°F (Sensed Temperature)	°C	Select temperature display to F or C
7	 and 	_____	_____	Exits user menu and returns to normal operation

- 1) Select keypad lockout OFF or ON** – Selecting **LOCK ON** will cause the keypad to be locked in the normal operation mode. This prevents the  and  from being used to adjust temperature. The display will indicate "**LOCK**" when the keypad is locked. If **LOCK OF** is selected, the  and  keys can still be used. When the keypad is locked, the  and  keys can still be pressed at the same time to enter the configuration menu.

**2) Select temporary adjust temperature hold time** – Selects the length of time for the temporary temperature adjustment. Hold time default is 4 hours and can be set from 1 to 8 hours in 1 hour increments.

**3) Select temperature display adjustment higher or lower** – allows you to adjust the room temperature display 1° to 4° higher or lower. Your sensor was accurately calibrated at the factory but you have the option to change the display temperature to match your previous sensor or thermostat.
- 4) Select display temperature OFF or ON** – Selecting **OF** allows you to disable displaying the sensed temperature. Instead of the temperature, the sensor will display "**PWR**" with the word **on** to indicate normal operation.
- 5) Select display backlight OFF or ON** - The display backlight improves display contrast in low lighting conditions. Selecting **dL on** will keep the light on for a short period of time after any key is pressed. Selecting **OF** will keep the light off.
- 6) Select temperature display to °F or °C** - Changes the display readout to Celsius or Fahrenheit as required.



# REMOTE SENSOR CONFIGURATION MENU

## Installer Configuration Menu

Your thermostat is configured at the factory to recognize the remote sensor it is shipped with as indoor sensor A. The Installer Configuration Menu is used only when adding or replacing a remote sensor or selecting a frequency offset.

Press and buttons for a minimum of five seconds at the same time to enter the Installer menu. To scroll through the menu items, momentarily press the and buttons at the same time. To change the item option, press or . To exit the menu scroll through all menu items. If no buttons are pushed for 3 minutes, the control will return to normal operation. The Installer Configuration Menu table summarizes the configuration options. An explanation of each option follows.

**Installer Configuration Menu**

Step	Press button(s) to scroll menu	Displayed (factory default)	Press  or  to change options	Comments
1	and	<b>LEARN</b> (OF)	on	Select learn mode OFF or ON
2	and	<b>CH</b> (A)	B, C, O	Select sensor identification as A, B, C or O
3	and	<b>C</b> (0)	1 through 9	Select transmitter frequency offset
4	and	_____	_____ operation	Exit installer menu and return to normal

- Select learn mode OFF or ON** – Selecting **LEARN** on enables the sensors learning mode. In the learning mode the sensor will transmit identification information once every 10 seconds for a period of 10 minutes. The LEARN icon will be displayed during the learning mode. The transmitter icon will be displayed for a short period of time with each transmission. See Learn Mode Option.
- Select sensor identification from A to O** – For multiple sensors systems, each sensor must have a designated identification. The thermostat can operate with one indoor sensor and one outdoor sensor. For indoor sensors you may select A, B or C. For outdoor sensor you must select O.
- Select transmitter frequency offset** – The sensor's transmitter operates on 418MHz radio frequency by default. Interference may occur if another device or equipment operates on the same frequency. The interference may degrade the communications between the sensor and the thermostat. To avoid interference, you may select a different radio frequency for your sensor. This menu item allows you to select a radio frequency offset from 1 to 9MHz from the base frequency. For example; if the you selected an offset of 4, the transmitter radio frequency will be 418MHz + 4MHz = 422MHz. Note that the sensor's transmitter and the thermostat's receiver must operate on the same frequency to communicate. To change thermostat's receiver frequency please refer to Thermostat Configuration Menu.

# OPERATING YOUR THERMOSTAT AND REMOTE SENSOR

## Check Thermostat Operation

### NOTE

To prevent static discharge problems, touch side of thermostat to release static build-up before touching any keys.

If at any time during testing your system does not operate properly, contact a qualified service person.

## Fan Operation

If your system does not have a **G** terminal connection, skip to **Heating System**.

- Turn on power to system.
- Move FAN switch to **ON** position. The blower should begin to operate.
- Move FAN switch to **AUTO** position. The blower should stop immediately.

### CAUTION

Do not allow the compressor to run unless the compressor oil heaters have been operational for 6 hours and the system has not been operational for at least 5 minutes.

## Heating System

- Press SYSTEM button to select **HEAT**. If the auxiliary heating system has a standing pilot, be sure to light it.
- Press to adjust thermostat setting to 1° above room temperature. The heat pump system should begin to operate. The display should show "**STG1**". However, if the system configuration is set to HP1 or HP2 and setpoint temperature display is flashing, the 5 minute compressor lockout feature is operating (see Configuration menu, item 10).
- Adjust temperature setting to 3° above room temperature. If your system configuration is set at MS2, HP2 or HP1, the auxiliary heat system should begin to operate and the display will show "**STG 1+2**".
- Press to adjust the thermostat below room temperature. The heating system should stop operating.

# OPERATING YOUR THERMOSTAT AND REMOTE SENSOR

## Emergency System

**EMER** bypasses the Heat Pump to use the heat source wired to terminal **E/W1** on the thermostat. **EMER** is typically used when compressor operation is not desired, or you prefer back-up heat only.

1. Press SYSTEM button to select **EMER**. "**EMER**" will flash on the display.
2. Press  $\ominus$  to adjust thermostat setting above room temperature. The Emergency heating system will begin to operate. The display will show "**STG1**" flashing "**EMER**" and "**HEAT**" to indicate that the Emergency system is operating.
3. Press  $\ominus$  to adjust the thermostat below room temperature. The Emergency heating system should stop operating.

## CAUTION

To prevent compressor and/or property damage, if the outdoor temperature is below 50°F, DO NOT operate the cooling system.

## Cooling System

1. Press SYSTEM button to select **COOL**.
2. Press  $\ominus$  to adjust thermostat setting below room temperature. The blower should come on immediately on high speed, followed by cold air circulation. The display should show "**STG1**". If the setpoint temperature display is flashing, the compressor lockout feature is operating (see Configuration menu, item 5).
3. Adjust temperature setting to 3° below room temperature. The second stage cooling should begin to operate and the display should show "**STG 1+2**".
4. Press  $\ominus$  to adjust the temperature setting above room temperature. The cooling system should stop operating.

## Remote Temperature Sensor Information on the Thermostat Display

During normal operation, the upper left of the thermostat display changes every 6 seconds to show the temperatures at the sensors that are turned on in the configuration menu. The sensors are the thermostat (**LOCAL**), the outdoor remote sensor (**OUTDOOR**) and the indoor remote sensor (**REMOTE**). Below that, the display alternately shows the time and temperature average of the sensors that are turned on.

The word "**SIGNAL**" is shown along with number of bars (1-3) indicating the relative signal strength. More bars mean better reception. The **antenna** icon also displays for few seconds when information from the remote sensor is received.

If the thermostat does not receive an update signal from an enabled remote sensor (**REMOTE** or **OUTDOOR**) for 30 minutes or more, the thermostat will display **FAULT** and **ANTENNA** icons continuously. The **REMOTE** or **OUTDOOR** sensor that has communication with the thermostat interrupted will display a temperature of 00. If the active sensor is the **REMOTE**, the thermostat will revert back to **LOCAL** sense only mode.

## Automatic System Changeover

When the thermostat is in the **AUTO** mode, the thermostat will call for heat or cool depending on the room temperature. The setpoint temperature displayed will be the last mode called. If the last system cycle was heat, the **HEAT** setpoint will be displayed. If the room temperature raises above the **HEAT** setpoint and the **COOL** setpoint and a call for cool is required, the temperature displayed will change to be the **COOL** setpoint.

If you manually override the temperature in **AUTO** and it does not switch to the mode (**HEAT** or **COOL**) that you want, press the  $\ominus$  and  $\ominus$  keys once, at the same time to switch modes. At the end of your override time it will revert back to **AUTO**.

## Second Stage Time Delay

Your thermostat is designed to determine the optimum time to activate the second stage. Simply raising the temperature in heating or lowering it in cooling will not always force the thermostat to bring the second stage on quickly. If the fast second stage option in the configuration menu (step 12) is set to "**OFF**", there is a delay from 0-30 minutes depending on the performance of the first stage of the system.

**EXAMPLE:** For the last 2 hours the thermostat is set on 70° and the room temperature is 70° with the equipment using only the first stage of heat. Since the equipment is keeping the temperature within 1 degree of setpoint, the thermostat will delay second stage for a longer time if you manually raise the temperature or if the room temperature quickly changes. Once the second stage comes on, it will come on sooner the next time there is a difference between the setpoint and the room temperature. The net effect of the staging program is that when the first stage is capable of holding temperature, the second stage will delay longer.

When the thermostat calculates that first stage cannot make temperature in a reasonable time, the second stage will come on sooner. This built in function automatically optimizes the use of additional stages of heat or cool.

# OPERATING YOUR THERMOSTAT AND REMOTE SENSOR

## Learn Mode Option

Your thermostat is configured at the factory to recognize the wireless remote sensor shipped with it. This sensor is stored as Sensor A. The Learn Mode Option must be performed on the thermostat and wireless remote sensor if:

- A wireless remote sensor is added to another channel.
- The wireless remote sensor is replaced.
- The thermostat is replaced.

During the Learn Mode, the wireless remote sensor will transmit identification information every ten seconds for ten minutes. In this ten-minute period, the display will show "LEARN" and the antenna icon will show for a short time with each transmission. The thermostat will be receiving the transmitted identification information.

To perform the Learn Mode on the thermostat and sensor:

Remove the batteries from all wireless remote sensors in the same building except the sensor you are going to put into the Learn Mode. This will prevent interference from the other sensors.

Be sure that the remote sensor is set for the proper identification (A, B or C for indoor or O for outdoor) and the thermostat and remote sensor are set to the same frequency.

On the thermostat, enter the thermostat Configuration Menu by pressing the **SYSTEM** button to **OFF** and then momentarily pressing  $\ominus$  and  $\ominus$  at the same time.

Momentarily press **SYSTEM** button to advance to step 2 of the Configuration Menu. The display will show "LER" and "OFF".

Momentarily press  $\ominus$  or  $\ominus$  to select "LER" and "On". The display will flash "LER" with "On" displayed constantly.

On the wireless remote sensor, enter the Installer Configuration Menu by pressing  $\ominus$  and  $\ominus$  for five seconds. The remote sensor display will change to "LEARN OF".

Momentarily press  $\ominus$  or  $\ominus$  to select "LEARN On".

After the thermostat has successfully identified the remote sensor in approximately one minute, the sensor information will be stored and the thermostat display will change to "LER" and "OK".

If the identification sequence is not successful after ten minutes, the thermostat display will show "LER", "Fault" and the antenna icon. If the Learn Mode is unsuccessful, refer to Troubleshooting section, Antenna + Fault.

If you are replacing a thermostat that has more than one wireless remote sensor, the Learn Mode must be performed for each sensor. Once a sensor has been identified, it will remain in the thermostat memory until the Learn Mode is performed again and a different sensor for the stored channel is identified.

## Wireless Remote Indoor Temperature Averaging

Your thermostat is designed to sense the temperature of the indoor remote sensor and average or weight it with the local sensor in the thermostat for each program period. The averaging will only be active when both the local and the indoor remote sensors are functional and turned on in the configuration menu. When the thermostat is placed in view schedule mode (press PRGM once), the weight of the indoor remote sensor will be shown on the left side of the display when **HOLD** button is pressed. The weighting classes of the indoor remote sensor are designated as **A** (default for average weight), **HI** (high weight), or **LO** (low weight). The **HI** weight is two times the weight of the average weight. The **A** weight is two times the weight of the **LO** weight. The weight of the local sensor is fixed to **A** (average weight). The actual temperature displayed, in the clock digits, in the normal operation mode is the mathematical weighted sum of the enabled functioning sensors. For example, if the local sensed temperature is 80°F and the remote sensed temperature is

70°F then:

If weight selected is **HI**, then the averaged temperature is  $(2 \times (80^\circ\text{F}) + 4 \times (70^\circ\text{F})) / 6 = 73.3^\circ\text{F}$ .

If weight selected is **A**, then the averaged temperature is  $(2 \times (80^\circ\text{F}) + 2 \times (70^\circ\text{F})) / 4 = 75^\circ\text{F}$ .

If weight selected is **LO**, then the averaged temperature is  $(2 \times (80^\circ\text{F}) + 1 \times (70^\circ\text{F})) / 3 = 76.6^\circ\text{F}$ .

The example above shows that the weight selected would prioritize the overall averaged temperature between the two sensors. The high weight selection caused the remote sensor to carry more weight in the calculated temperature average than the local sensor. The low weight selection caused the remote sensor to carry less weight in the calculated temperature average than the local sensor.

## Choose the Fan Setting (Auto or On)

Set the FAN Switch to **Auto** or **On**.

Fan **Auto** is the most commonly selected setting and runs the fan only when the heating or cooling system is on.

Fan **On** runs the fan continuously for increased air circulation or to allow additional air cleaning.

## Choose the System Setting (Heat, Off, Cool, Auto, Emer)

Press the **SYSTEM** button to select:

**Heat:** Thermostat controls only the heating system.

**Off:** Heating and Cooling systems are off.

**Cool:** Thermostat controls only the cooling system.

**Auto:** Auto Changeover is used in areas where both heating and cooling may be required on the same day. **AUTO** allows the thermostat to automatically select heating or cooling depending on the indoor temperature and the selected heat and cool temperatures. When using **AUTO**, be sure to set the Cooling temperatures more than 1° Fahrenheit higher than the heating temperature.

**Emer:** Setting is available only when the thermostat is configured in HP1 or HP2 mode.

## Manual Operation for Non-Programmable Thermostats

Press the **SYSTEM** button to select Heat or Cool and use the  $\ominus$  or  $\ominus$  buttons to adjust the temperature to your desired setting. After selecting your desired settings you can also press the **SYSTEM** button to select **AUTO** to allow the thermostat to automatically change between Heat and Cool.

## Manual Operation (Bypassing the Program) Programmable Thermostats

Press  $\ominus$  or  $\ominus$  and adjust the temperature wherever you like. Then press **HOLD**. This will override the program. The **HOLD** feature bypasses the program and allows you to adjust the temperature manually, as needed. Whatever temperature you set in **HOLD** will be maintained 24 hours a day, until you manually change the temperature or press **RUN** to cancel **HOLD** and resume the programmed schedule.

## Program Override (Temporary Override)

Press  $\ominus$  or  $\ominus$  buttons to adjust the temperature. This will override the temperature setting for a (default) four hour override period. The override period can be shortened or lengthened by adjusting the temporary hold time in the configuration menu.

**Example:** If you turn up the heat during the morning program, it will be automatically lowered later, when the temporary hold period ends. To cancel the temporary setting at any time and return to the program, press **RUN**.

If the **SYSTEM** button is pressed to select **AUTO** the thermostat will change to Heat or Cool, whichever ran last. If it switches to heat but you want cool, or it changes to cool but you want heat, press both  $\ominus$  and  $\ominus$  buttons simultaneously to change to the other mode.

# OPERATING YOUR THERMOSTAT AND REMOTE SENSOR

## Remote Sensor Operation

The sensor monitors the temperature and sends information to the thermostat. Updated information is sent to the thermostat when the temperature changes 3/16 degree or more from the last update.

**Low Battery power:** The sensor will display the word **LO** along with **BATT** icon to indicate a low battery power condition. The 2 "AAA" batteries must be replaced to ensure a proper sensor performance. For optimum performance, replace batteries once a year with new premium brand alkaline batteries such as Duracell® or Energizer®.

Increasing the sensor setpoint decreases the displayed remote temperature shown on the thermostat by 1°F per bar. This will lower the actual calculated room temperature by up to 4°F. Decreasing the sensor setpoint increases the displayed remote temperature and will raise the actual calculated room temperature. The table below shows how the adjustment on the sensor affects the displayed remote temperature on the thermostat and the calculated average temperature.

Description	Remote Sensor	Thermostat Display (Remote)	Thermostat Display (Local)	Calculated Room Temp.	Setpoint Temp.
Increasing setting decreases room temperature average causing system to increase temperature.	H +4 bars	Decreases by 4°F to 71°F	75°F	70.5°F	75°F
	H +3 bars	Decreases by 3°F to 72°F		71°F	
	H +2 bars	Decreases by 2°F to 73°F		71.5°F	
	H +1 bar	Decreases by 1°F to 74°F		72°F	
	Remote 75°F			74.5°	
Decreasing setting increases room temperature causing more of a demand for Cooling.	C -1 bar	Increases by 1°F to 76°F		73°F	
	C -2 bars	Increases by 2°F to 77°F		73.5°F	
	C -3 bars	Increases by 3°F to 78°F		74°F	
	C -4 bars	Increases by 4°F to 79°F	74.5°F		

## PROGRAMMING YOUR THERMOSTAT

This section will help you plan your thermostat's program to meet your needs. For maximum comfort and efficiency, keep the following guidelines in mind when planning your program.

- When heating (cooling) your building, program the temperatures to be cooler (warmer) when the building is vacant or during periods of low activity.
- During early morning hours, the need for cooling is usually minimal.

### Planning Your Program

Look at the factory preprogrammed times and temperatures shown in the sample schedule. If this program will suit your needs, simply set the time and day and press the RUN button to begin running the factory preset program.

If you want to change the preprogrammed times and temperatures, follow these steps.

Determine the time periods and temperatures for your program. You must program four periods for each day. However, you may use the same heating and cooling temperatures for consecutive time periods. You can choose start times, heating temperatures, and cooling temperatures independently (for example, you may select 5:00 AM and 70° as the weekday **1st period heating** start time and temperature and also choose 7:00 AM and 76° as the weekday **1st period cooling** start time and temperature).

Use the table to plan your program time periods and the temperatures you want during each period. Fill in the complete table to have a record of your programs.

### FACTORY PROGRAM

PERIOD	WEEKDAYS (5 DAYS)				SATURDAY (1 DAY)			SUNDAY (1 DAY)		
	START TIME	TEMP	REMOTE WEIGHT	START TIME	TEMP	REMOTE WEIGHT	START TIME	TEMP	REMOTE WEIGHT	
HEAT	MORN	6:00 AM	70 F	A	6:00 AM	70 F	A	6:00 AM	70 F	A
	DAY	8:00 AM	62 F	A	8:00 AM	62 F	A	8:00 AM	62 F	A
	EVE	5:00 PM	70 F	A	5:00 PM	70 F	A	5:00 PM	70 F	A
	NITE	10:00 PM	62 F	A	10:00 PM	62 F	A	10:00 PM	62 F	A
COOL	MORN	6:00 AM	78 F	A	6:00 AM	78 F	A	6:00 AM	78 F	A
	DAY	8:00 AM	85 F	A	8:00 AM	85 F	A	8:00 AM	85 F	A
	EVE	5:00 PM	78 F	A	5:00 PM	78 F	A	5:00 PM	78 F	A
	NITE	10:00 PM	82 F	A	10:00 PM	82 F	A	10:00 PM	82 F	A

### PERSONAL PROGRAM

PERIOD	WEEKDAYS (5 DAYS)				SATURDAY (1 DAY)			SUNDAY (1 DAY)		
	START TIME	TEMP	REMOTE WEIGHT	START TIME	TEMP	REMOTE WEIGHT	START TIME	TEMP	REMOTE WEIGHT	
HEAT	MORN									
	DAY									
	EVE									
	NITE									
COOL	MORN									
	DAY									
	EVE									
	NITE									

# PROGRAMMING

## Setting the Clock and Day

### Set Current Time and Day

1. Press TIME button once. The display will show the hour only.

EXAMPLE:

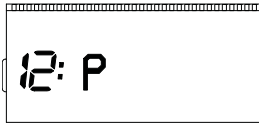

2. Press and hold either  $\ominus$  or  $\omin�$  until you reach the correct hour and AM/PM designation (**AM** begins at midnight; **PM** begins at noon). **A** will indicate for AM. **P** will indicate for PM in the minutes digits.
3. Press TIME once again. The display window will show the minutes only.

EXAMPLE:

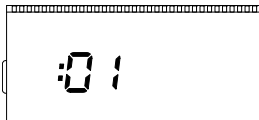

4. Press and hold either  $\ominus$  or  $\omin�$  until you reach the correct minutes.
5. Press TIME once again. The display will show the day of the week.
6. Press  $\omin�$  or  $\omin�$  until you reach the current day of the week.
7. Press RUN once. The display will show the correct time and room temperature alternately.

This thermostat starts the programmed temperature earlier than the time selected in your program. This allows the system to reach your setting by the time you specify in your program. This feature is called EMR (Energy Management Recovery). If you do not want the thermostat to start early, you may cancel the EMR feature in the Configuration Menu.

### Enter Heating Program

1. Press the SYSTEM button to **HEAT**.
2. Press PRGM once. "**MO TU WE TH FR**" (indicating weekday program) will appear in the display. Also displayed are the currently programmed start time for the 1st heating period and the currently programmed temperature (flashing).

EXAMPLE:

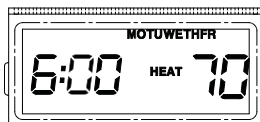

This display window shows that for the 1st weekday period, the start time is 6:00 AM and 68° is the programmed temperature (this example reflects factory preprogramming).

3. Press  $\omin�$  or  $\omin�$  to change the displayed temperature to your selected temperature for the 1st heating program period.
4. Press TIME once (the programmed time will flash). Press  $\omin�$  or  $\omin�$  until your selected time appears. The time will change in 15 minute increments. When your selected time is displayed, press TIME again to return to the change temperature mode.
5. If both the local and the remote sensors are enabled, then you may press HOLD button to change the remote sensor weighting setting. Remote icon will display. The programmed weight (A, HI or LO) will flash. Press  $\omin�$  or  $\omin�$  to change the displayed weight to your selected weight for the 1st heat program period.

6. Press PRGM once. The currently programmed start time and setpoint temperature for the **2nd heating** program period will appear.
7. Repeat steps 3 and 5 to select the start time and heating temperature for the 2nd heating program period.
8. Repeat steps 3 through 6 for the 3rd and 4th heating program periods.
9. Press PRGM once "**SA**" (indicating Saturday program) will appear in the display, along with the start time for the 1st heating period and the currently programmed temperature.
10. Repeat steps 3 through 8 to complete Saturday heating programming.
11. Press PRGM once to change to "**SU**" (Sunday) heating programming and repeat steps 3 through 7 to complete Sunday programming.
12. When you have completed entering your heating program, press RUN.

### Enter Cooling Program

#### CAUTION

If the outside temperature is below 50°F, disconnect power to the cooling system before programming. Energizing the air conditioner compressor during cold weather may cause personal injury or property damage.

1. Press SYSTEM button to **COOL**.
2. Follow Enter Heating Program for entering your cooling program, using your selected cooling times and temperatures.

### CHECK YOUR PROGRAMMING

Follow these steps to check your thermostat programming one final time before beginning thermostat operation.

1. Press SYSTEM button to **HEAT** position.
2. Press PRGM to view the 1st weekday heating period time and temperature. Each time you press PRGM, the next heating period time and temperature will be displayed in sequence for weekday, then Saturday and Sunday program periods (you may change any time or temperature during this procedure).
3. Press RUN.
4. Press SYSTEM button to **COOL** position.
5. Repeat step 2 to check cooling program.
6. Press SYSTEM button to **HEAT** or **COOL** and press RUN to begin program operation.

NOTE: Batteries are not required to keep your programming or menu data. With two optional "AA" batteries installed, your thermostat will maintain time and continuously display the temperature during a loss of AC power. Installed batteries will also allow programming prior to installation.



**YOUR THERMOSTAT IS NOW PROGRAMMED AND READY TO PROVIDE MAXIMUM COMFORT AND EFFICIENCY!**



# TROUBLESHOOTING

## Reset Operation

If a voltage spike or static discharge blanks out the display or causes erratic thermostat operation, you can reset the thermostat by removing the wires from terminals R and C and removing batteries for 2 minutes. After resetting the thermostat, replace the wires and batteries. If the thermostat has been reset and still does not function correctly contact your heating/cooling service person or place of purchase.





Pressing  and  and the SYSTEM keys at the same time will reset the thermostat to its factory default setting. This will also clear any limited temperature ranges or keypad lockout settings. Note default system configuration is multistage system operation.

Symptom	Possible Cause	Corrective Action
<b>No Heat/No Cool/No Fan (common problems)</b>	<ol style="list-style-type: none"> <li>1. Blown fuse or tripped circuit breaker.</li> <li>2. Furnace power switch to OFF.</li> <li>3. Furnace blower compartment door or panel loose or not properly installed.</li> </ol>	<p>Replace fuse or reset breaker. Turn switch to ON. Replace door panel in proper position to engage safety interlock or door switch.</p>
<b>No Heat</b>	<ol style="list-style-type: none"> <li>1. Pilot light not lit.</li> <li>2. SYSTEM Switch not set to <b>HEAT</b>.</li> <li>3. Loose connection to thermostat or system.</li> <li>4. Furnace Lock-Out Condition. Heat may also be intermittent.</li> <li>5. Heating system requires service or thermostat requires replacement.</li> </ol>	<p>Re-light pilot. Set SYSTEM Switch to <b>HEAT</b> and raise setpoint above room temperature. Verify thermostat and system wires are securely attached. Many furnaces have safety devices that shut down when a lock-out condition occurs. If the heat works intermittently contact the furnace manufacturer or local service person for assistance. Diagnostic: Set SYSTEM Switch to <b>HEAT</b> and raise the setpoint above room temperature. Within a few seconds the thermostat should make a soft click sound. This sound usually indicates the thermostat is operating properly. If the thermostat does not click, try the reset operation listed above. If the thermostat does not click after being reset contact your heating and cooling service person or place of purchase for a replacement. If the thermostat clicks, contact the furnace manufacturer or a service person to verify the heating is operating correctly.</p>
<b>No Cool</b>	<ol style="list-style-type: none"> <li>1. SYSTEM Switch not set to <b>COOL</b>.</li> <li>2. Loose connection to thermostat or system.</li> <li>3. Cooling system requires service or thermostat requires replacement.</li> </ol>	<p>Set SYSTEM Switch to <b>COOL</b> and lower setpoint below room temperature. Verify thermostat and system wires are securely attached. Same procedure as diagnostic for No Heat condition except set the thermostat to <b>COOL</b> and lower the setpoint below the room temperature. There may be up to a five minute delay before the thermostat clicks in Cooling.</p>
<b>Thermostat does not Follow Program</b>	<ol style="list-style-type: none"> <li>1. Program or current time(s) set incorrectly (AM, PM or Day of the week).</li> <li>2. Energy Management Recovery (EMR) starting the program early.</li> </ol>	<p>Verify that the AM or PM settings are correct for each program period and the current time of day. Also verify the Day of the week is set correctly. The EMR (Energy Management Recovery) feature starts early to achieve the temperature it is programmed for by the time specified in the program. See the Configuration Menu section to disable EMR if you do not want the thermostat to start early.</p>

# TROUBLESHOOTING

Symptom	Possible Cause	Corrective Action
<b>Furnace Inducer Fan, Blower or Heat Turns On with No Call for Heat or does not Turn Off when Call for Heat Ends</b>	In power stealing mode (RC/PS Switch set to PS), the thermostat draws a small amount of power through the heating circuit to operate. Some furnace systems using high impedance input electronic modules may react to the current draw and actuate system components.	<ol style="list-style-type: none"> <li>1. Add a common connection from the system transformer to the "C" terminal on the thermostat and set the RC/PS switch to RC.</li> <li>2. If the system has a standard cooling contactor and no common connection is available at the thermostat, clip jumper W25-W1 and separate the ends. This prevents the thermostat from drawing power from the W1 (heating) circuit. If the condition persists after clipping the jumper, a heating and cooling service person can install an isolation relay to the system or add a common wire as mentioned above.</li> </ol>
<b>Antenna + Fault</b>	<ol style="list-style-type: none"> <li>1. Loss of power from heating/cooling system to thermostat.</li> <li>2. Remote sensor too far from thermostat.</li> <li>3. Thermostat or remote sensor set to different channels or a different frequency offset.</li> <li>4. Incorrect sensor identification selected.</li> <li>5. Replacement Sensor requires running learn mode.</li> <li>6. Remote sensor requires replacement.</li> </ol>	<ol style="list-style-type: none"> <li>1. Verify the thermostat is operating on AC power by removing the thermostat batteries. If display goes blank, AC power is lost.</li> <li>2. Change remote sensor location.</li> <li>3. Verify the thermostat and remote sensor are set to the same channel and frequency offset.</li> <li>4. For indoor sensor, verify sensor identification selected is A, B or C. For an outdoor sensor, verify the sensor identification selected is O.</li> <li>5. If the sensor did not come with this thermostat from the factory, perform the learn procedure for thermostat and sensor.</li> <li>6. If the sensor display indicate E0 or E1, replace the remote sensor.</li> </ol>
<b>Temperature Difference between Thermostat and Remote Location</b>	<ol style="list-style-type: none"> <li>1. Improper system sizing or improper heating and cooling distribution between areas.</li> <li>2. An uneven change in occupancy level, sun load or conditioned space activities (cooking, washing dishes, showers, etc.) between the areas.</li> </ol>	Selecting a high or low priority for the thermostat or sensor location during program periods can help even out minor temperature imbalances between the thermostat and remote sensor locations. This is also useful for scheduled or predictable events like occupancy level or sun load during particular times of the day. If the temperature difference remains large after assigning priorities, system modification or zoning may be necessary to balance the temperature distribution.
<b>Heat, Cool or Fan Runs Constantly</b>	<ol style="list-style-type: none"> <li>1. Possible short in wiring.</li> <li>2. Possible short in thermostat.</li> <li>3. Possible short in heat/cool/fan system.</li> <li>4. FAN Switch set to Fan <b>ON</b>.</li> </ol>	Check each wire connection to verify they are not shorted or touching together. No bare wire should stick out from under terminal screws. Try resetting the thermostat as described above. If the condition persists the manufacturer of your system or service person can instruct you on how to test the Heat/Cool system for correct operation. If the system operates correctly, replace the thermostat.

# TROUBLESHOOTING

Symptom	Possible Cause	Corrective Action
<b>Furnace (Air Conditioner) Cycles Too Fast or Too Slow (narrow or wide temperature swing)</b>	1. The location of the thermostat and/or the size of the Heating System may be influencing the cycle rate.	Digital thermostats normally provide precise temperature control and may cycle faster than some older mechanical models. A faster cycle rate means the unit turns on and off more frequently but runs for a shorter time so there is no increase in energy use. If you would like to increase the cycle time, choose <b>SL</b> for slow cycle in the menu, step 4. If an acceptable cycle rate is not achieved as received or by choosing slow cycle, contact a local service person for additional suggestions.
<b>Thermostat Setting &amp; Thermostat Thermometer Disagree</b>	1. Thermostat thermometer setting requires adjustment.	The thermometer can be adjusted +/- 3 degrees. See Temperature Display Adjustment in the Configuration Menu section.
<b>Blank Display and/or Keypad Not Responding</b>	1. Voltage spike or static discharge.	Use the Reset Operation at top of previous page.
<b>Heat Setpoint will not Respond to the Temperature Up Key</b>	1. The desired setpoint conflicts with the setpoint of the COOL mode.	Change system mode to COOL. Raise the Cool setpoint. Return to HEAT mode and set desired temperature.
<b>Cool Setpoint will not Respond to the Temperature Down Key</b>	1. The desired setpoint conflicts with the setpoint of the HEAT mode.	Change system mode to HEAT. Lower the Heat setpoint. Return to COOL mode and set desired temperature.
<b>Forgot Keypad Lockout Code</b>		With the thermostat in any mode, press  and  at the same time to enter the configuration menu at the point where the lockout code is to be entered. Press  and  and SYSTEM button at the same time to reset the lockout code, unlock the keypad.
<b>Why won't my 2nd or 3rd stage come on?</b>		Your thermostat is designed to determine the optimum time to activate the second stage. Simply raising the temperature in heating or lowering it in cooling will not always force the thermostat to bring the second stage on quickly. There is a time delay from 0-30 minutes depending on the performance of the first stage of the system.

**HOMEOWNER HELP LINE: 1-800-284-2925**

White-Rodgers is a division of Emerson Electric Co.

The Emerson logo is a trademark and service mark of Emerson Electric Co.

**White**  
**Rodgers**

St. Louis, MO

www.white-rodgers.com

  
**EMERSON**  
Climate Technologies